

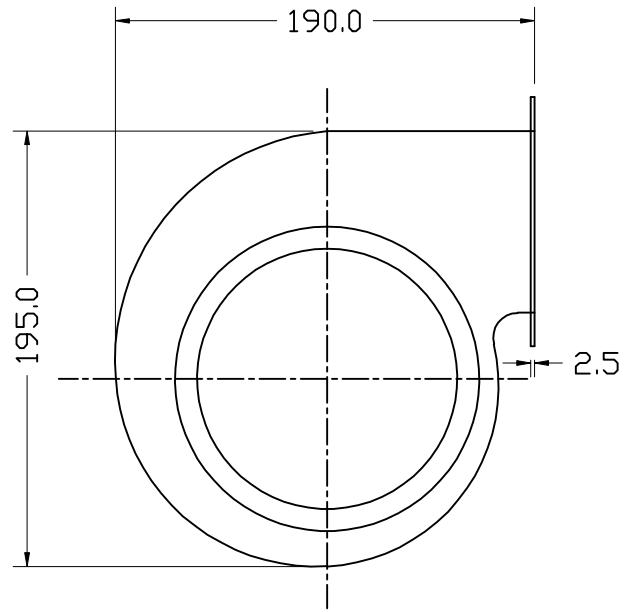

TECHNICAL DATA SHEET

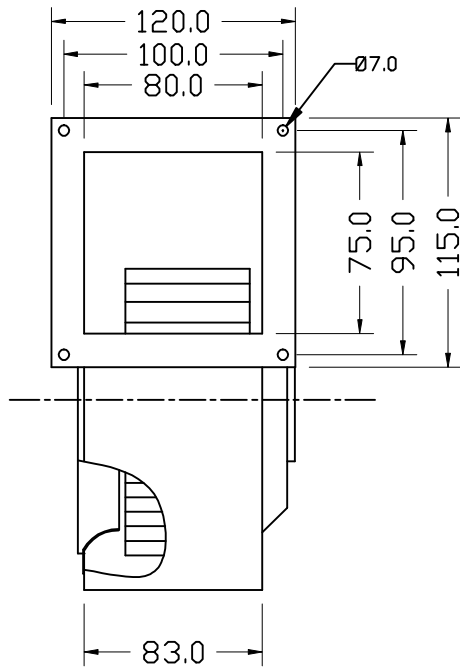

SPECIFICATION (50Hz)

Voltage (V)	230
Watt (W)	76
Amps (A)	0.32
Speed (rpm)	2450
Capacitor (μ F)	2.0
Airflow (m^3/hr)	350
Noise (db)	74
Net Weight (Kg)	3.0

PERFORMANCE CURVE

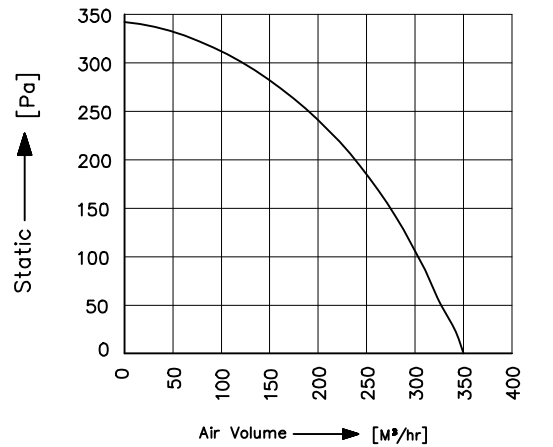

Conversion: 100pa \approx 0.4" H2O 100m³/hr \approx 60cfm

All information contained in this document is CONFIDENTIAL and the property of VBM. Reproduction of this any form is to be done with the specific permission of the company.

*Material :

- Impeller: G.I, Zinc Plated
- Housing: Steel, powder coated
- Rotor: Powder coated

*Type of protection: IP-54

*Insulation Class: "F"- Class

*Bearing: Maintenance free Ball Bearing.

*Permissible ambient temperature: 0 to 60° C

*High Voltage test according to IS: 3588-1987

*Balancing Grade: Fans conform 2.5 Grade as recommended by IS 1940-1973

*Direction of rotation: Clockwise, Seen on rotor

*Wiring Diagram :

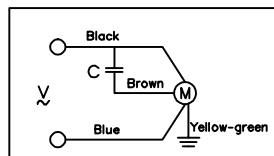

NOTE: ALL DIMENSIONS ARE IN MM.

MODEL : SI23/140-28/S2

SCALE: NTS | Page 1 of 1

REV/DATE: 01,29.11.2013

PREPARED BY : J.G.P

CHECKED BY : S.B.D

